

Article number: 439600140

Description: Rota-fix shaft-hub connection FS140x190

Note: Self centering - very high torque.

Measures

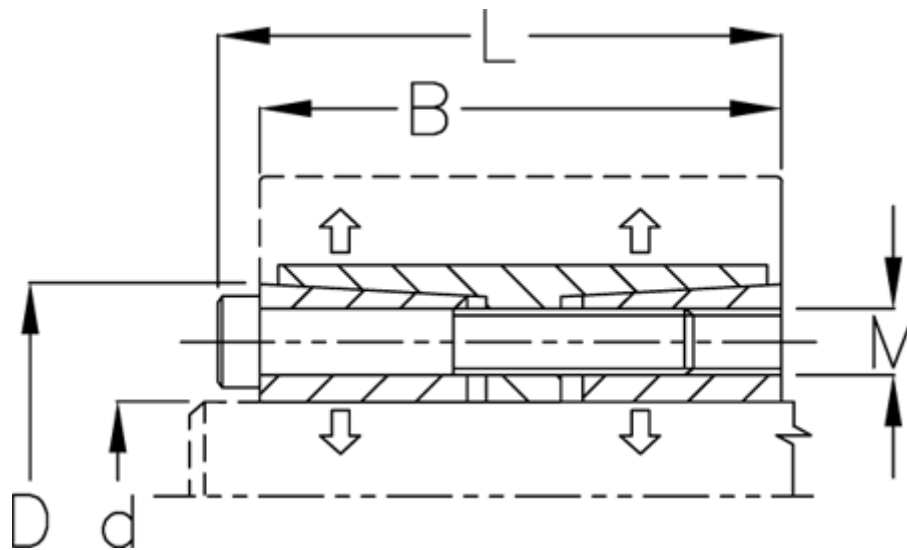

B mm	= 82
d H8 mm	= 140
D mm	= 190
Fit tolerance	= Aksel h8, Nav H8
F kN torque	= 583.0
L mm	= 94
M mm	= M12
P N/mm ² surface pressure on shaft/hub	= 151

Surface roughness	= R? ? 3.2 μ m
T N m torque	= 40800
Ts N m bolt tightening torque	= 145.0